

**COURSE OVERVIEW EE0419**

**Electrical Faults, Causes, Analysis, Detection & Remedies for Safe Operation, Maintenance of Electrical Switchgear**

**Course Title**

Electrical Faults, Causes, Analysis, Detection & Remedies for Safe Operation, Maintenance of Electrical Switchgear

**Course Date/Venue**

July 07-11, 2024/Boardroom, Warwick Hotel Doha, Doha, Qatar

**Course Reference**

EE0419

**Course Duration/Credits**

Five days/3.0 CEUs/30 PDHs

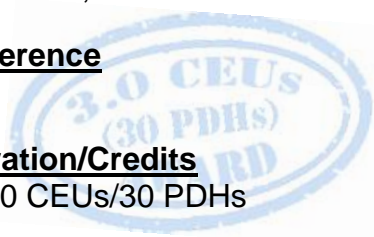

**Course Description**



***This practical and highly-interactive course includes various practical sessions and exercises. Theory learnt in the class will be applied using our state-of-the-art simulators.***



This course is designed to provide participants with a detailed and up-to-date overview of Electrical Faults, Causes, Analysis, Detection & Remedies for Safe Operation, Maintenance of Electrical Switchgear. It covers the purpose and types of electrical switchgear; the components and configurations of switchgear systems and safety considerations in operating and maintaining switchgear; the common electrical faults encountered in switchgear; the causes and consequences of electrical faults; and the fault analysis techniques, visual inspection and condition assessment.



Further, the course will also discuss the electrical testing methods, thermographic imaging, vibration analysis and online monitoring systems; the early fault detection, switchgear monitoring systems, protective relay systems, circuit breakers, fault detection and alarm systems and remote monitoring options; the safety protocols for working with electrical switchgear; and the lockout/tagout procedures and personnel safety; and the regular maintenance and inspections, lubrication, cleaning, tightening of switchgear components, record-keeping and documentation.

During this interactive course, participants will learn the fault isolation and identification techniques; repairing and replacing faulty components, restoring electrical insulation, ARC flash mitigation strategies and effective grounding and earthing techniques; the pre-commissioning checks and inspections, functional testing of switchgear components and testing and calibrating protective relays; the control interlocking systems; the commissioning documentation and procedures; the emergency response procedures for electrical faults; identifying critical faults requiring immediate action and troubleshooting techniques for fault localization; the rapid repairing and recovering strategies; and the post-fault analysis and investigation.

### **Course Objectives**

Upon the successful completion of this course, each participant will be able to:-

- Apply and gain an in-depth knowledge on electrical faults, causes, analysis, detection and remedies for safe operation, maintenance of electrical switchgear
- Discuss the purpose and types of electrical switchgear as well as identify the components and configurations of switchgear systems and safety considerations in operating and maintaining switchgear
- Identify the common electrical faults encountered in switchgear and the causes and consequences of electrical faults
- Apply fault analysis techniques, visual inspection and condition assessment
- Carryout electrical testing methods, thermographic imaging, vibration analysis and online monitoring systems
- Employ early fault detection, switchgear monitoring systems, protective relay systems, circuit breakers and fault detection and alarm systems and remote monitoring options
- Implement safety protocols for working with electrical switchgear including lockout/tagout procedures and personnel safety
- Apply regular maintenance and inspections, lubrication, cleaning, tightening of switchgear components, record-keeping and documentation
- Carryout fault isolation and identification techniques, repair and replace faulty components, restoring electrical insulation, ARC flash mitigation strategies and effective grounding and earthing techniques
- Perform pre-commissioning checks and inspections, functional testing of switchgear components and testing and calibration of protective relays
- Verify control interlocking systems and apply commissioning documentation and procedures
- Apply emergency response procedures for electrical faults, identify critical faults requiring immediate action and troubleshoot techniques for fault localization
- Employ rapid repair and recover strategies including post-fault analysis and investigation

### Exclusive Smart Training Kit - H-STK®



Participants of this course will receive the exclusive “Haward Smart Training Kit” (H-STK®). The H-STK® consists of a comprehensive set of technical content which includes **electronic version** of the course materials conveniently saved in a **Tablet PC**.

### Who Should Attend

This course provides an overview of all significant aspects and considerations of electrical faults, causes, analysis, detection and remedies for safe operation, maintenance of electrical switchgear for electrical engineers, electrical technicians, electrical inspectors, electrical maintenance personnel, electricians, electrical safety professionals and facility managers.

### Training Methodology

All our Courses are including **Hands-on Practical Sessions** using equipment, State-of-the-Art Simulators, Drawings, Case Studies, Videos and Exercises. The courses include the following training methodologies as a percentage of the total tuition hours:-

- 30% Lectures
- 20% Practical Workshops & Work Presentations
- 30% Hands-on Practical Exercises & Case Studies
- 20% Simulators (Hardware & Software) & Videos

In an unlikely event, the course instructor may modify the above training methodology before or during the course for technical reasons.

### Course Fee

**US\$ 6,000** per Delegate. This rate includes H-STK® (Haward Smart Training Kit), buffet lunch, coffee/tea on arrival, morning & afternoon of each day.

### Accommodation

Accommodation is not included in the course fees. However, any accommodation required can be arranged at the time of booking.

### Course Certificate(s)

Internationally recognized certificates will be issued to all participants of the course who completed a minimum of 80% of the total tuition hours.

### Certificate Accreditations

Certificates are accredited by the following international accreditation organizations: -

- 

The International Accreditors for Continuing Education and Training (IACET - USA)

Haward Technology is an Authorized Training Provider by the International Accreditors for Continuing Education and Training (IACET), 2201 Cooperative Way, Suite 600, Herndon, VA 20171, USA. In obtaining this authority, Haward Technology has demonstrated that it complies with the **ANSI/IACET 2018-1 Standard** which is widely recognized as the standard of good practice internationally. As a result of our Authorized Provider membership status, Haward Technology is authorized to offer IACET CEUs for its programs that qualify under the **ANSI/IACET 2018-1 Standard**.

Haward Technology's courses meet the professional certification and continuing education requirements for participants seeking **Continuing Education Units (CEUs)** in accordance with the rules & regulations of the International Accreditors for Continuing Education & Training (IACET). IACET is an international authority that evaluates programs according to strict, research-based criteria and guidelines. The CEU is an internationally accepted uniform unit of measurement in qualified courses of continuing education.

Haward Technology Middle East will award **3.0 CEUs** (Continuing Education Units) or **30 PDHs** (Professional Development Hours) for participants who completed the total tuition hours of this program. One CEU is equivalent to ten Professional Development Hours (PDHs) or ten contact hours of the participation in and completion of Haward Technology programs. A permanent record of a participant's involvement and awarding of CEU will be maintained by Haward Technology. Haward Technology will provide a copy of the participant's CEU and PDH Transcript of Records upon request.

- 

British Accreditation Council (BAC)

Haward Technology is accredited by the **British Accreditation Council** for **Independent Further and Higher Education** as an **International Centre**. BAC is the British accrediting body responsible for setting standards within independent further and higher education sector in the UK and overseas. As a BAC-accredited international centre, Haward Technology meets all of the international higher education criteria and standards set by BAC.

### Course Instructor(s)

This course will be conducted by the following instructor(s). However, we have the right to change the course instructor(s) prior to the course date and inform participants accordingly:



**Mr. Sherif Bayoumi, BSc, is a Senior Electrical Engineer with over 40 years of extensive experience within Oil, Gas, Petrochemical and Power industries. His expertise widely covers Electrical Systematics Troubleshooting, Electrical Distribution Systems & Control Circuits, Electrical Parameters, Symmetrical & Unsymmetrical Faults, Electrical Drawings, Relay Logic Circuits, Test Requirements, Component Testing Procedures, Electrical & Control System, Troubleshooting Transformers, Equipment Troubleshooting, System Grounding, Circuit Breakers, Protection Devices & Technology, Protection Relay, Solid State Relay, Instrument Transformers, Grading & Protection Coordination, Electrical System & Equipment, Generators, Gas Turbine, Diesel Generators, Power Transformers, AC & DC Motors, Substations, Switchgears & Distribution, Power System Analysis, Electrical Equipment Control Systems, Cables & Domestic Wiring, Overhead Transmission Lines, Electrical Safety, Electrical Protection, Batteries, Chargers & UPS, Electrical Projects Handling, Electrical Measurements, Medium Voltage Switchgears (MVSG), Motor Control Centers (MCC), Electrical Submersible Pumps (ESP). He is also well-versed in Preventive Maintenance, Health, Safety & Environmental Management System (HSEMS), On-Shore & Off-Shore Electrical Installations, Engineering Studies, Water Desalination Units, Induction Motors, Power Supply Substations, Electro-mechanical Protection Relays, Engineering Drawings, Industrial Power System Coordination, Machinery Vibration, Dynamic Balancing Analysis, Material & Equipment Standard & Code System, Hazardous Area Classification, Safety Management System, Emergency Response, Permit to Work & Issuing Authority, Defensive Driving and Task Risk Assessment.**

During Mr. Sherif's career life, he has occupied various key positions in several companies such as the **Electrical Maintenance Engineer, Senior Electrical Support Engineer, Lead Maintenance Electrical Engineer, Maintenance Electrical Engineer, Specialist Electrical Engineer in Abu Dhabi Company for Onshore Oil Operations (ADCO), Gulf of Suez Petroleum Company (GUPCO) and West Desert Petroleum Company (WEPCO).**

Mr. Sherif has a **Bachelor's degree in Electrical Power Engineering.** Further, he is a **Certified Instructor/Trainer** and has delivered numerous courses, trainings, workshops, seminars and conferences internationally.

### **Course Program**

The following program is planned for this course. However, the course instructor(s) may modify this program before or during the course for technical reasons with no prior notice to participants. Nevertheless, the course objectives will always be met:

#### **Day 1: Sunday, 07<sup>th</sup> of July 2024**

0730 – 0800	Registration & Coffee
0800 – 0815	Welcome & Introduction
0815 – 0830	<b>PRE-TEST</b>
0830 – 0945	<b>Introduction to Electrical Switchgear</b> Definition & Purpose of Electrical Switchgear • Types of Electrical Switchgear (LV, MV, HV)
0945 – 1000	Break
1000 – 1200	<b>Introduction to Electrical Switchgear (cont'd)</b> Components & Configurations of Switchgear Systems • Safety Considerations in Operating & Maintaining Switchgear
1200 – 1215	Break
1215 – 1300	<b>Common Electrical Faults in Switchgear</b> Common Electrical Faults Encountered in Switchgear • Short Circuits, Overloads, Insulation Failures & Earth Faults
1300 – 1420	<b>Common Electrical Faults in Switchgear (cont'd)</b> Causes & Consequences of Electrical Faults • Importance of Fault Detection & Prevention
1420 – 1430	<b>Recap</b>
1430	Lunch & End of Day One

#### **Day 2: Monday, 08<sup>th</sup> of July 2024**

0730 – 0930	<b>Fault Analysis Techniques</b> Visual Inspection & Condition Assessment • Electrical Testing Methods (IR Testing, Power Factor Measurement, Etc.)
0930 – 0945	Break
0945 – 1100	<b>Fault Analysis Techniques (cont'd)</b> Thermographic Imaging & Vibration Analysis • Introduction to Online Monitoring Systems
1100 – 1200	<b>Fault Detection &amp; Monitoring</b> Importance of Early Fault Detection • Monitoring Systems for Switchgear • Protective Relay Systems & their Functions
1200 – 1215	Break
1300 – 1420	<b>Fault Detection &amp; Monitoring (cont'd)</b> Circuit Breakers & Fault Detection Mechanisms • Alarm Systems & Remote Monitoring Options
1420 – 1430	<b>Recap</b>
1430	Lunch & End of Day Two

#### **Day 3: Tuesday, 09<sup>th</sup> of July 2024**

0730 – 0930	<b>Safe Operation &amp; Maintenance Practices</b> Safety Protocols for Working with Electrical Switchgear • Lockout/Tagout Procedures & Personnel Safety • Importance of Regular Maintenance & Inspections
0930 – 0945	Break
0945 – 1100	<b>Safe Operation &amp; Maintenance Practices (cont'd)</b> Lubrication, Cleaning & Tightening of Switchgear Components • Record-Keeping & Documentation

1100 – 1200	<b>Remedies for Electrical Faults</b> <i>Fault Isolation &amp; Identification Techniques • Repair &amp; Replacement of Faulty Components • Techniques for Restoring Electrical Insulation</i>
1200 – 1215	<i>Break</i>
1215 – 1300	<b>Remedies for Electrical Faults (cont'd)</b> <i>ARC Flash Mitigation Strategies • Techniques for Effective Grounding &amp; Earthing</i>
1420 – 1430	<b>Recap</b>
1430	<i>Lunch &amp; End of Day Three</i>

**Day 4: Wednesday, 10<sup>th</sup> of July 2024**

0730 – 0930	<b>Switchgear Testing &amp; Commissioning</b> <i>Pre-Commissioning Checks &amp; Inspections • Functional Testing of Switchgear Components • Testing &amp; Calibration of Protective Relays</i>
0930 – 1045	<b>Switchgear Testing &amp; Commissioning (cont'd)</b> <i>Verification of Control &amp; Interlocking Systems • Commissioning Documentation &amp; Procedures</i>
1045 – 1100	<i>Break</i>
1100 – 1215	<b>Emergency Response &amp; Fault Handling</b> <i>Emergency Response Procedures for Electrical Faults • Identifying Critical Faults Requiring Immediate Action • Troubleshooting Techniques for Fault Localization</i>
1215 – 1230	<i>Break</i>
1230 – 1420	<b>Emergency Response &amp; Fault Handling (cont'd)</b> <i>Rapid Repair &amp; Recovery Strategies • Post-Fault Analysis &amp; Investigation</i>
1420 – 1430	<b>Recap</b>
1430	<i>Lunch &amp; End of Day Four</i>

**Day 5: Thursday, 11<sup>th</sup> of July 2024**

0730 – 0900	<b>Case Studies &amp; Practical Exercises</b> <i>Analyzing Real-World Electrical Fault Scenarios • Exercises for Fault Detection &amp; Diagnosis</i>
0900 – 0915	<i>Break</i>
0915 – 1100	<b>Case Studies &amp; Practical Exercises (cont'd)</b> <i>Simulated Fault Handling Exercises</i>
1100 – 1200	<b>Review &amp; Assessment</b> <i>Recap of Key Concepts and Techniques covered in the Course • Review of Case Studies &amp; Practical Exercises • Assessment to Evaluate Participants' Knowledge &amp; Understanding</i>
1200 – 1215	<i>Break</i>
1215 – 1345	<b>Review &amp; Assessment (cont'd)</b> <i>Q &amp; A to Address Any Remaining Queries</i>
1345 – 1400	<b>Course Conclusion</b>
1400 – 1415	<b>POST-TEST</b>
1415 – 1430	<i>Presentation of Course Certificates</i>
1430	<i>Lunch &amp; End of Course</i>

### Simulator (Hands-on Practical Sessions)

Practical sessions will be organized during the course for delegates to practice the theory learnt. Delegates will be provided with an opportunity to carryout various exercises using our state-of-the-art simulators “Troubleshooting Electrical Circuits V4.1”, Power World” and “ETAP software”.

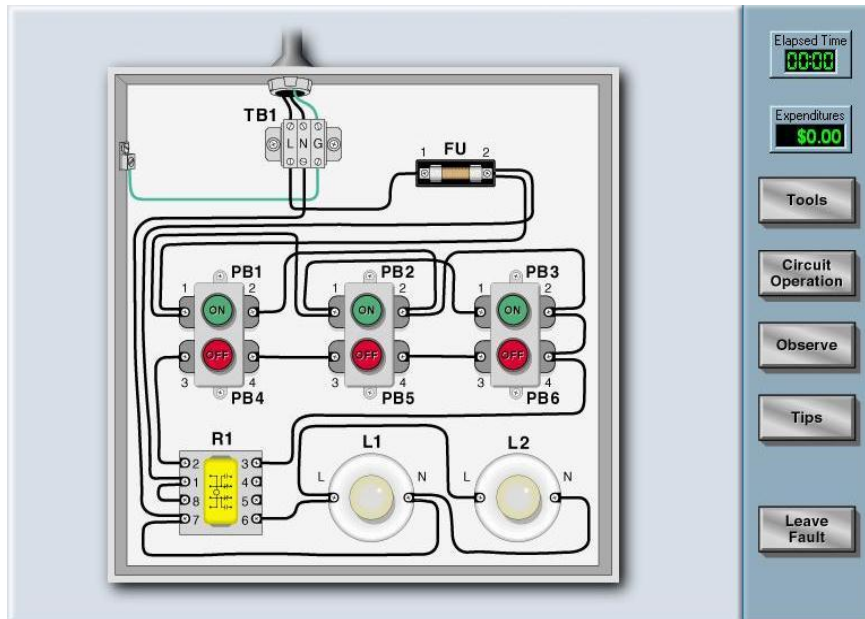

### Basic Techniques

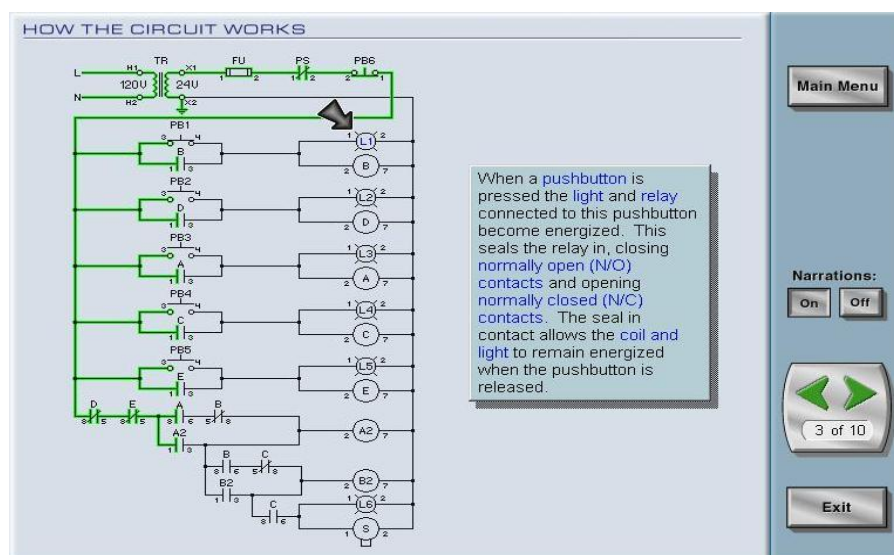

### Basic Control Circuits



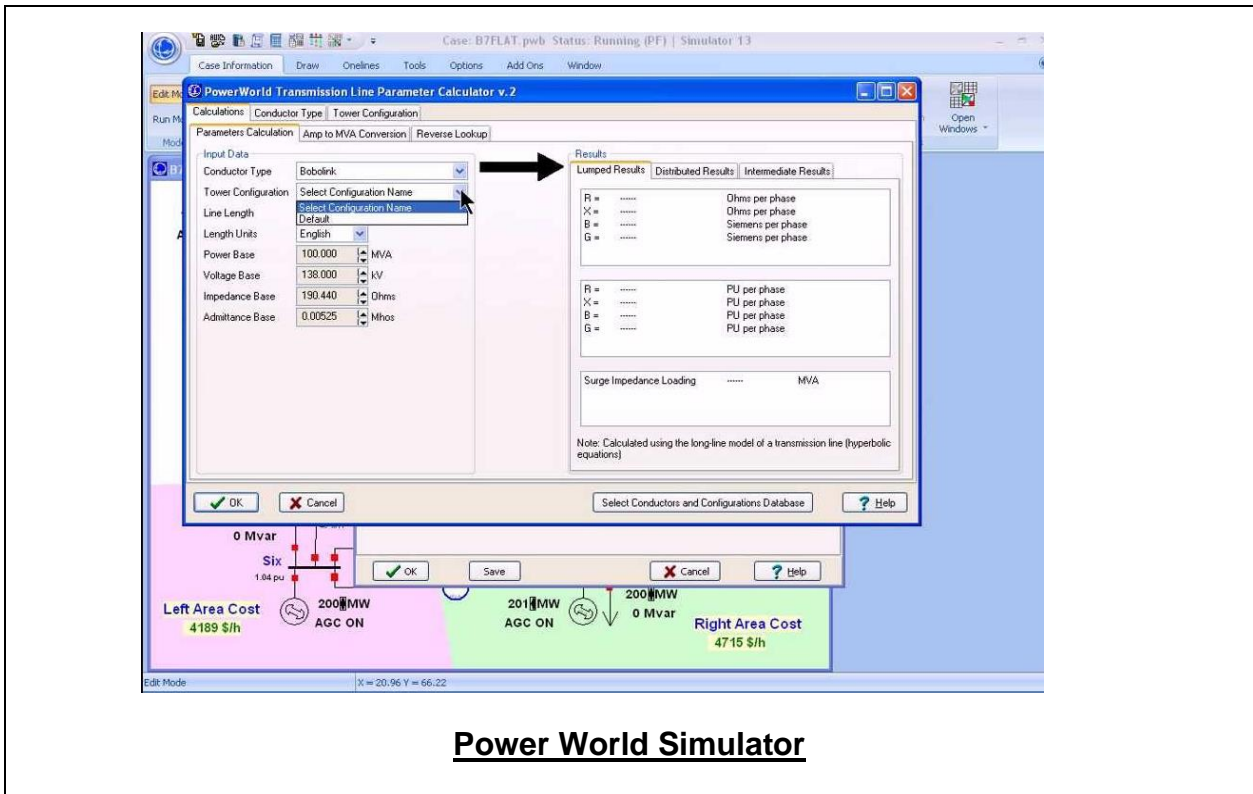
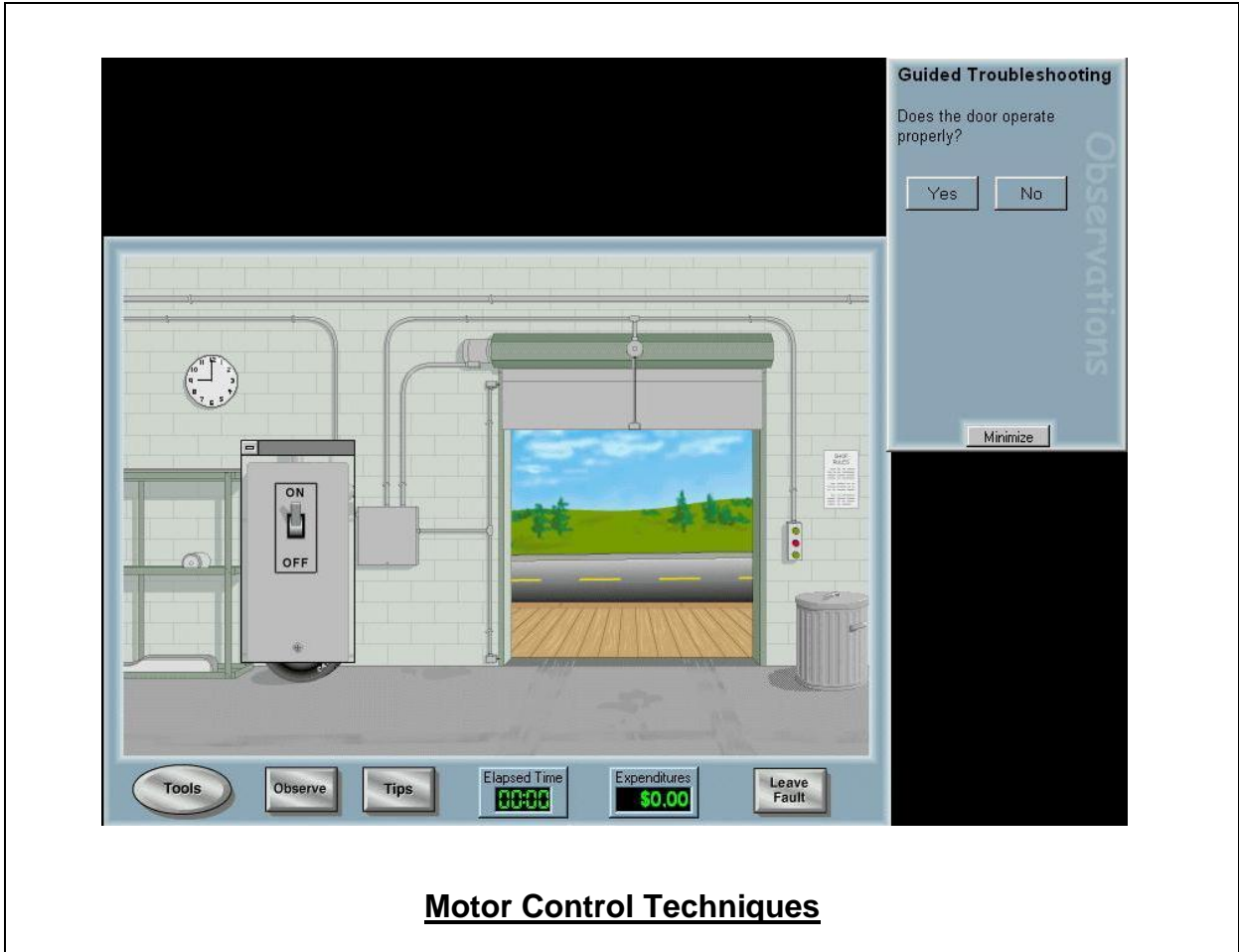

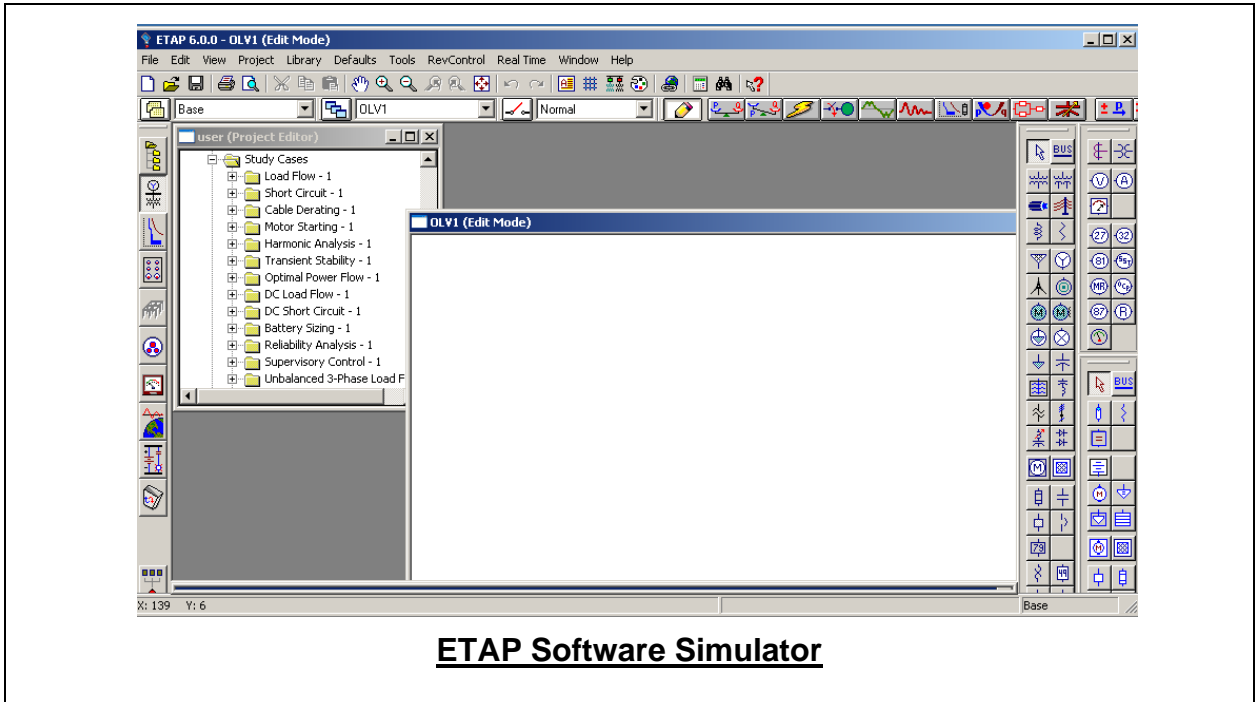

**ETAP Software Simulator**

**Course Coordinator**

Jaryl Castillo, Tel: +974 4 45 28 133, Email: [jaryl@haward.org](mailto:jaryl@haward.org)